

1

2

3

4

5

A

A

B

B

C

C

D

D

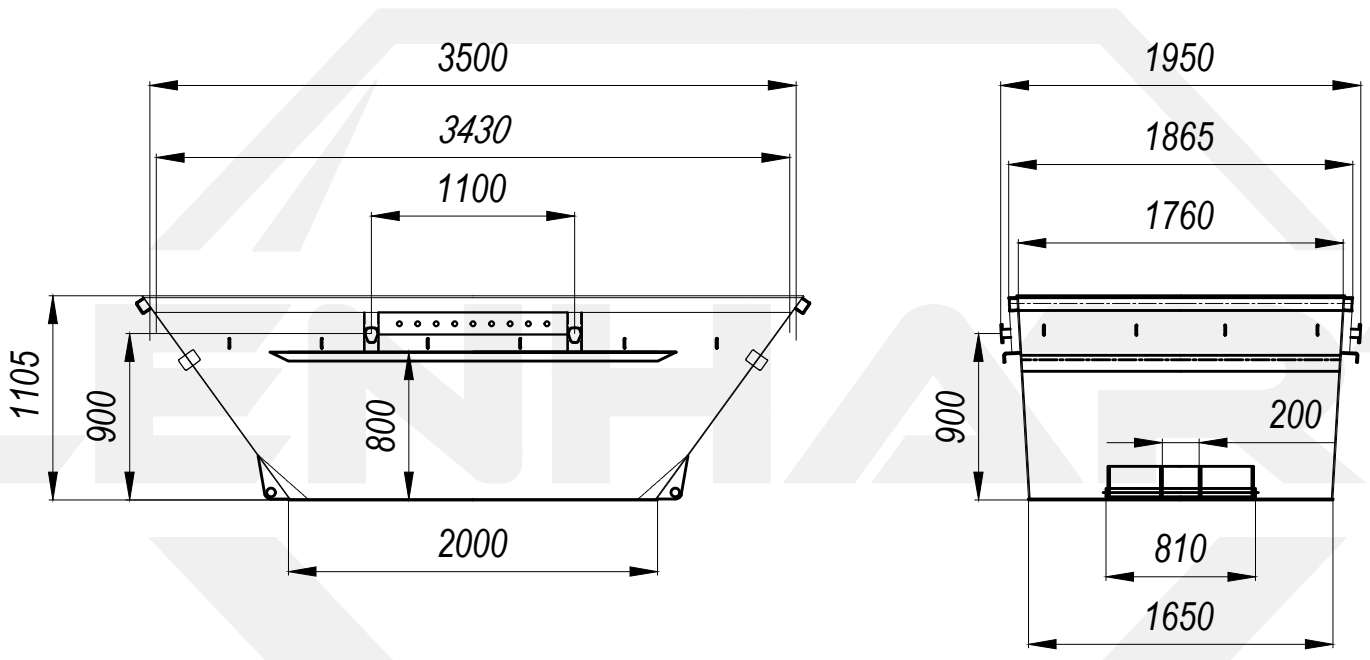

ABSETZCONTAINER S-5m3 nach DIN 30-720-1



1

2

3

4

5