

1

2

3

4

5

A

A

B

B

C

C

D

D

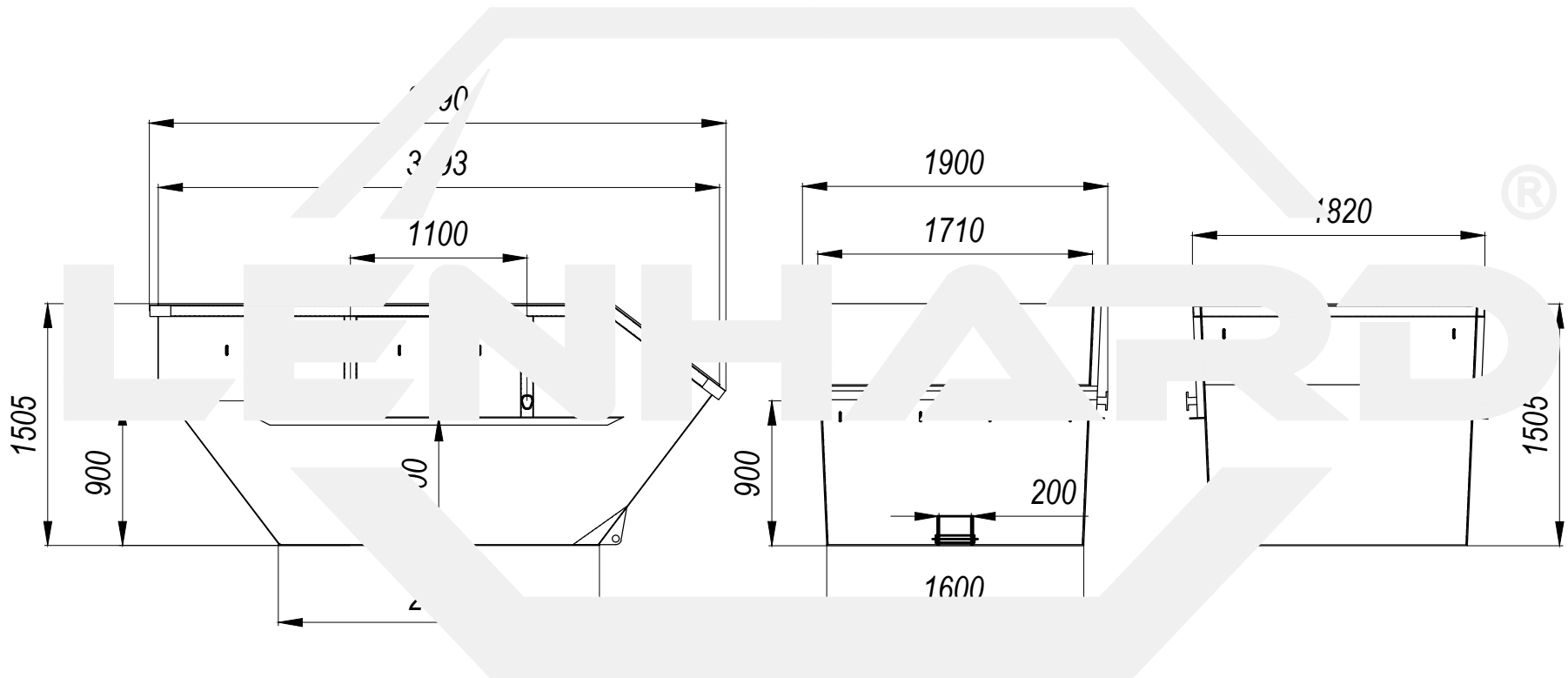

ABSETZCONTAINER A-7m3 nach DIN 30-720



1

2

3

4

5