

1

2

3

4

5

A

A

B

B

C

C

D

D

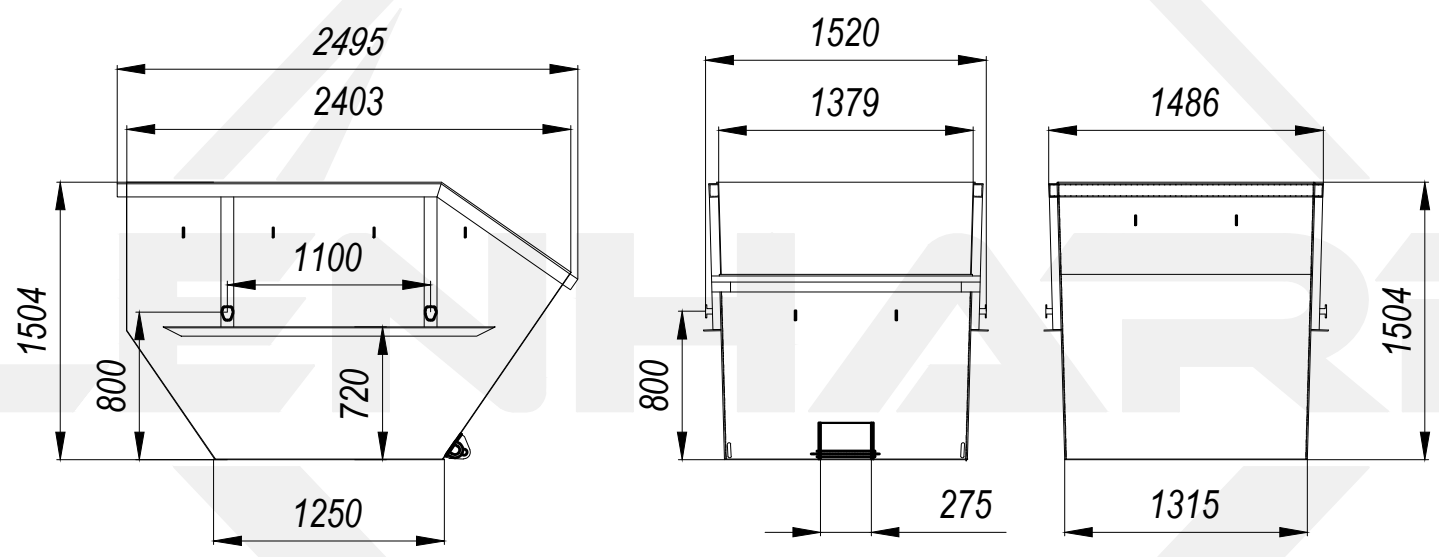

**ABSETZCONTAINER 4m3 nach DIN 30735**



1

2

3

4

5