

1

2

3

4

5

A

A

B

B

C

C

D

D

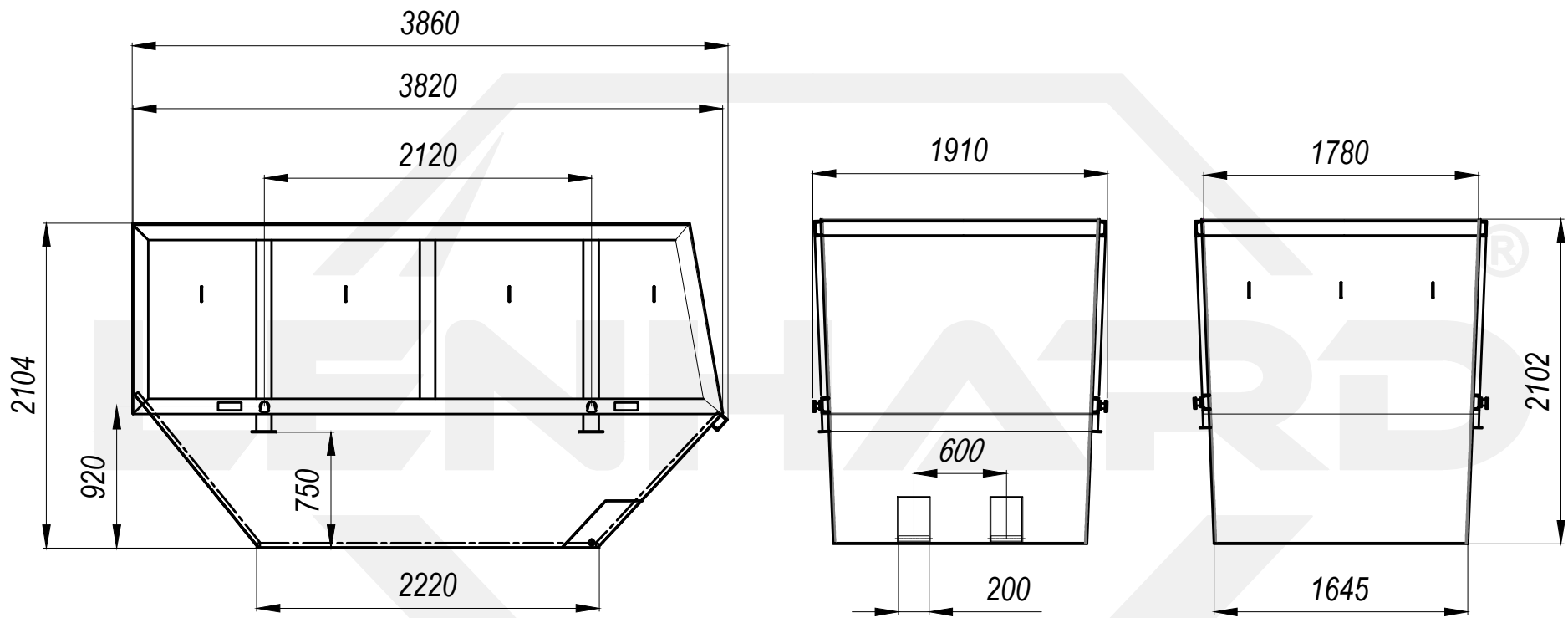

MULTIBENNE A15m3



1

2

3

4

5