

1

2

3

4

5

A

A

B

B

C

C

D

D

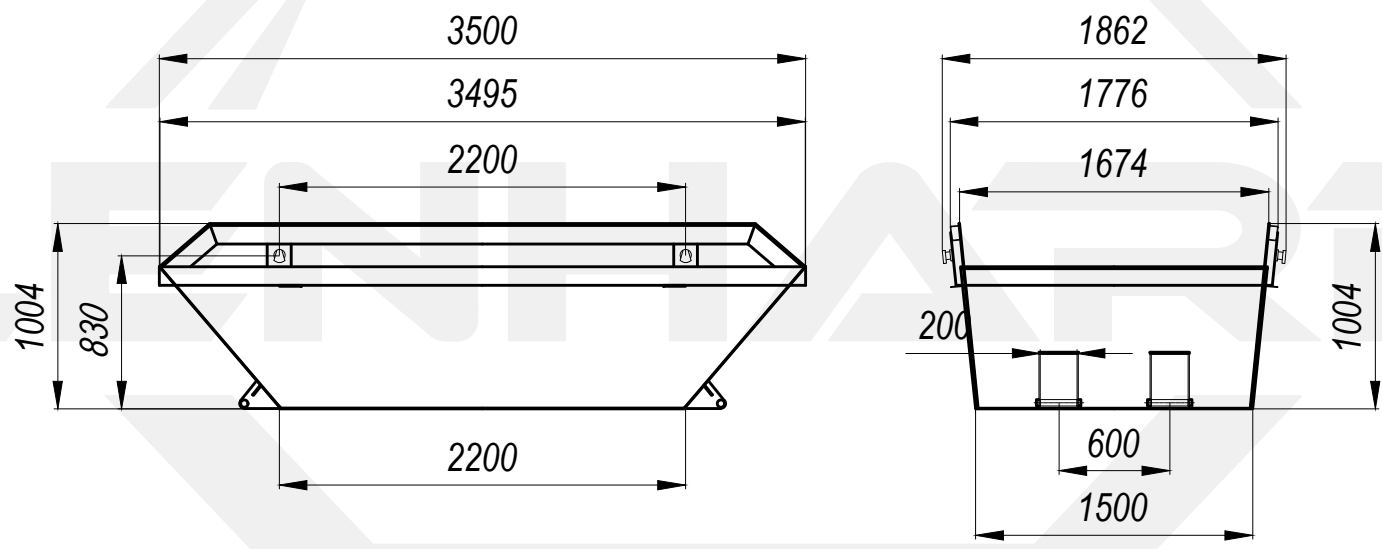

**MULTIBENNE S5m3**



1

2

3

4

5