

1

2

3

4

5

A

A

B

B

C

C

D

D

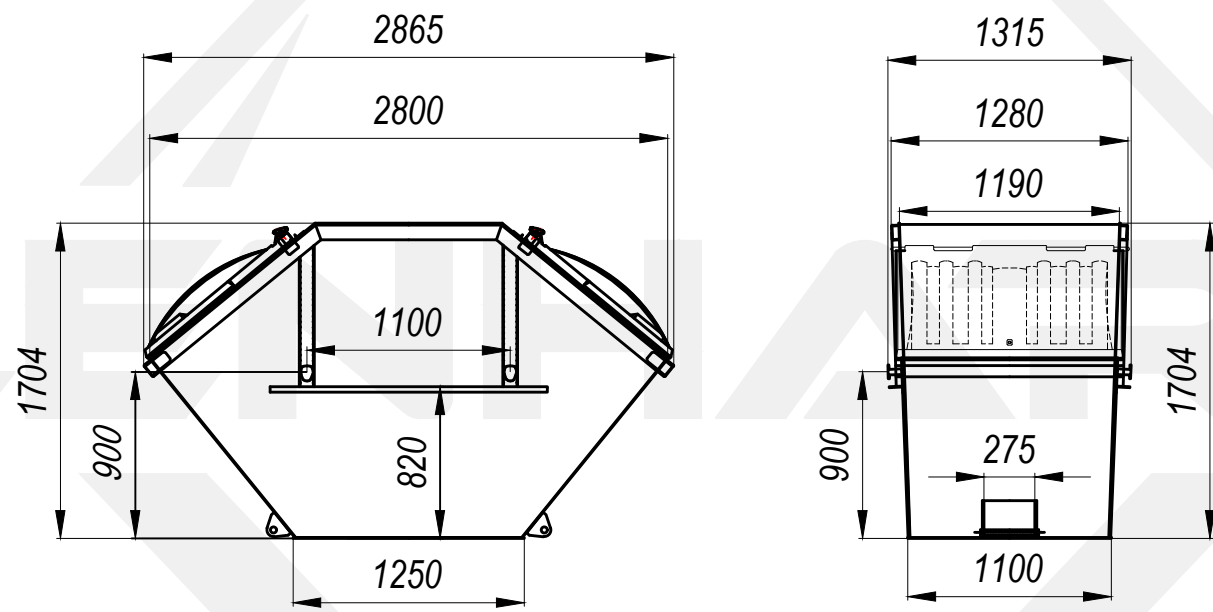

ABSETZCONTAINER 4.0m3 MULTICAR



1

2

3

4

5